



Audi RS3 Cat Back Installation Instructions

XFORCE RECOMMENDS AN AUTHORISED PROFESSIONAL TO INSTALL ALL PRODUCTS

WARNING: When working on any vehicle exercise extreme caution. Please allow the vehicles exhaust system to be cool enough to touch before removal. Failing to do so may result in severe burns. If working without a hoist refer to the vehicles manual to check correct lifting specifications. Always wear safety glasses, protective gloves and ensure your working in a safe area. Serious injury or death can occur if the correct safety measures are not followed.

Attention: Please read the instructions carefully. XFORCE will only warrant manufacturing faults. This does not extend to damage or breakage due to incorrect fitment.



Parts List

1. ES-RS317 C1 (Front Y pipe)
2. ES-RS317 C2 (Rear Y Pipe)
3. 2 x 2 ½" Clamps
4. 2 x 2 bolt Gasket, Nuts and Bolts
5. ES-RS317 VMKR (Varex rear muffler)
6. ES-RS317 TIPR+TIPL
7. VK02 (Varex Control Wiring Kit)



Required Tools and Equipment

1. Spanners and Sockets required 10mm, 13mm, 14mm, 15mm, 16mm
2. 3/8" Ratchet
3. 6" long 3/8 Extension bar
4. Can of spray lubricant
5. Tube of O2 Sensor safe sealant for the 2 bolt Gasket and Slip Joints
6. 2-3 Rags for excess sealant
7. Safety Glasses or Goggles
8. Protective Gloves
9. Safety Boots



IMPORTANT STEP

Loosely run the wiring from inside the vehicle to the outside through an open door. Plug the wiring harness into the 12V socket and then into the muffler and control box and power up. Check the operation of all electronics and Muffler valve before installation.

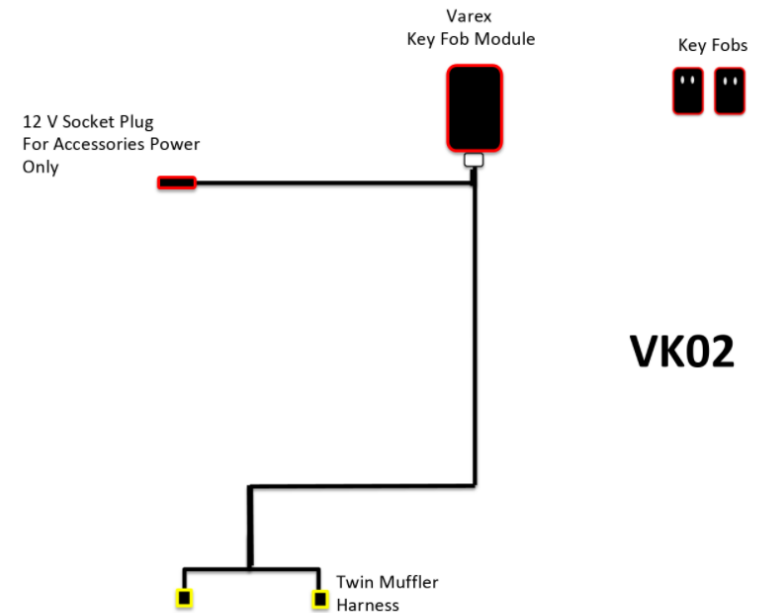



Step 1

The entire fitting process must be conducted by a professionally trained technician (this also includes hoist operation).

1 Raise vehicle on a 2 post hoist making sure hoist arms are in the correct lifting positions (as per owners manual) and that you or someone else **IS NOT** under the vehicle while hoist is moving. Once the Vehicle is at a workable height engage the hoist safety locks.

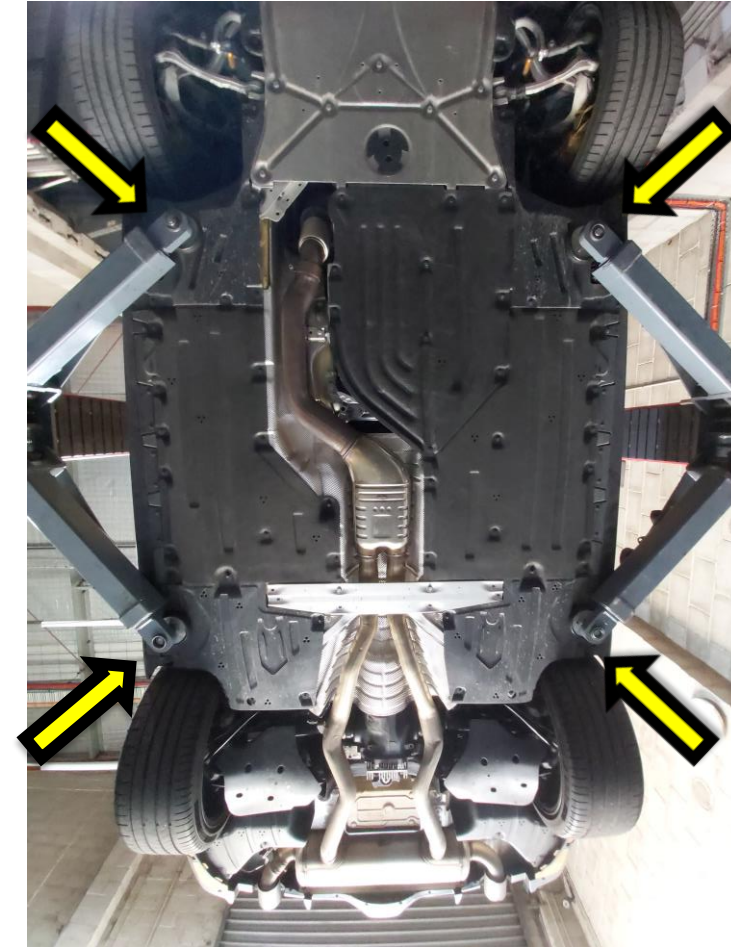



Step 2

Please make sure you are wearing safety equipment as listed in Required Tools/Equipment
Unbolt the 4 x 13mm nuts on the 2 x clamps in the centre of the exhaust and the 4 x 13mm nuts and remove the centre brace in the middle of the car.

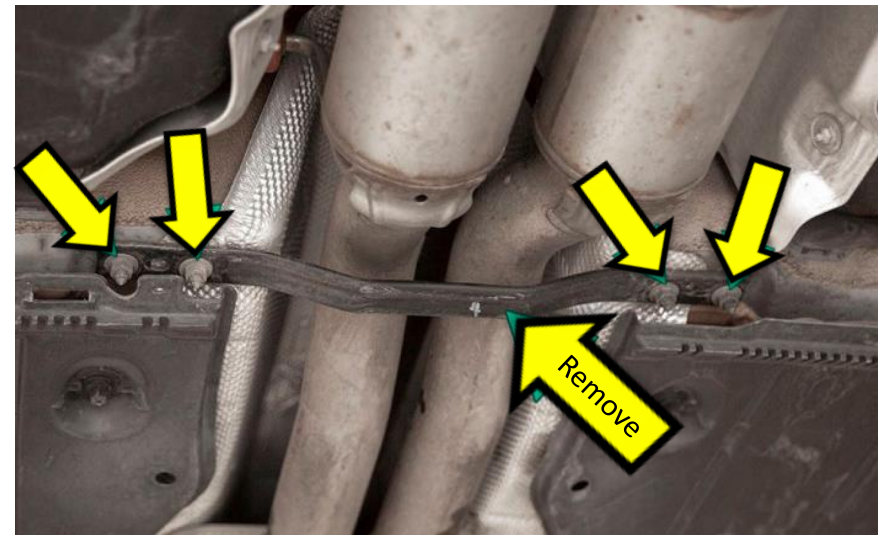
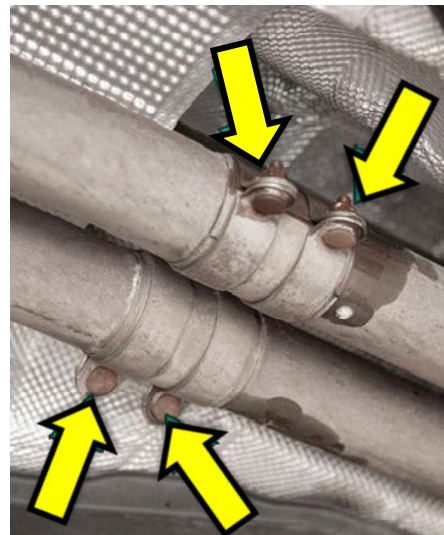



Step 3

Push down on the tab and pull the wiring harness out of the left and right factory exhaust motors





Step 4

- 1 Spray lubricant between the 4 x Rubbers and Exhaust Hangers
- 2 Using a 13mm socket unbolt the 2 x nuts on the 2 rear hangers, and the 1 x middle hanger.

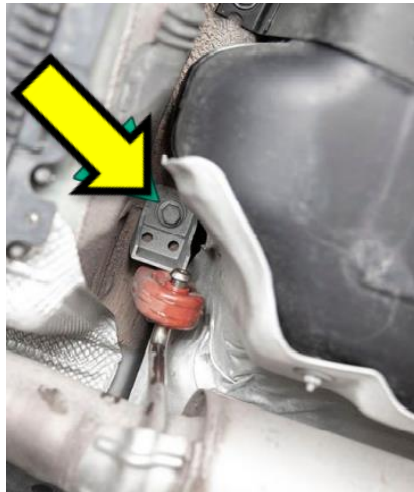



Step 5

1 On a bench or the floor connect the C1 (Y pipe) to the C2 using O2 sensor safe sealant (as per the diagram) and leave finger tight. Lift the connected parts and put the front and rear hangers into the rubbers.

2 Slide the factory clamps over the factory down pipe and C1





Step 6

1 Fit the 2 rubbers and rear hangers on the muffler .

2 With help from another person raise the Xforce muffler into position on the Vehicle and refit the 13mm nuts into the hangers on the Chassis

3 Bolt to the rear muffler 2 bolt flange to the C2 making sure you have O2 sensor safe sealant on both sides of the gasket.





Step 7

Tighten everything firm (**NOT TIGHT**) from the rear to the front making sure you have at least a fingers gap from the heat shielding, support brace and body of the vehicle. If you don't have enough gap twist and slide the system until you are happy with the gap the tighten everything tight.

Last of all fit the 2 tips and adjust to the desired position and tighten the clamps with a 10mm spanner or socket.



Step 8

1 Check the rear muffler and tips are level and even, check the gaps at all points of the exhaust are enough and haven't moved in the tightening process. Once you are satisfied Disengage the hoist safety locks and lower the vehicle.



Note: When you first start your vehicle after the installation of your new XFORCE Performance Exhaust System, there may be some smoke and fumes coming from the system. This is a protective oil based coating used in the manufacturing of mandrel bent performance exhaust tubing. This is not a problem and will disappear within a very short period of time after the exhaust has reached normal operating temperatures.



VAREX

Varex Key Fob wiring Installation Instructions

XFORCE RECOMMENDS AN AUTHORISED PROFESSIONAL TO INSTALL ALL PRODUCTS

WARNING: When working on any vehicle exercise extreme caution. Please allow the vehicles exhaust system to be cool enough to touch before removal. Failing to do so may result in severe burns. If working without a hoist refer to the vehicles manual to check correct lifting specifications. Always wear safety glasses, protective gloves and ensure your working in a safe area. Serious injury or death can occur if the correct safety measures are not followed.

Attention: Please read the instructions carefully. XFORCE will only warrant manufacturing faults. This does not extend to damage or breakage due to incorrect fitment.



What's inside the box

- 1 Varex Control Module
- 2 Main Wiring Harness (VK1 or VK2)
- 3 Key Fobs



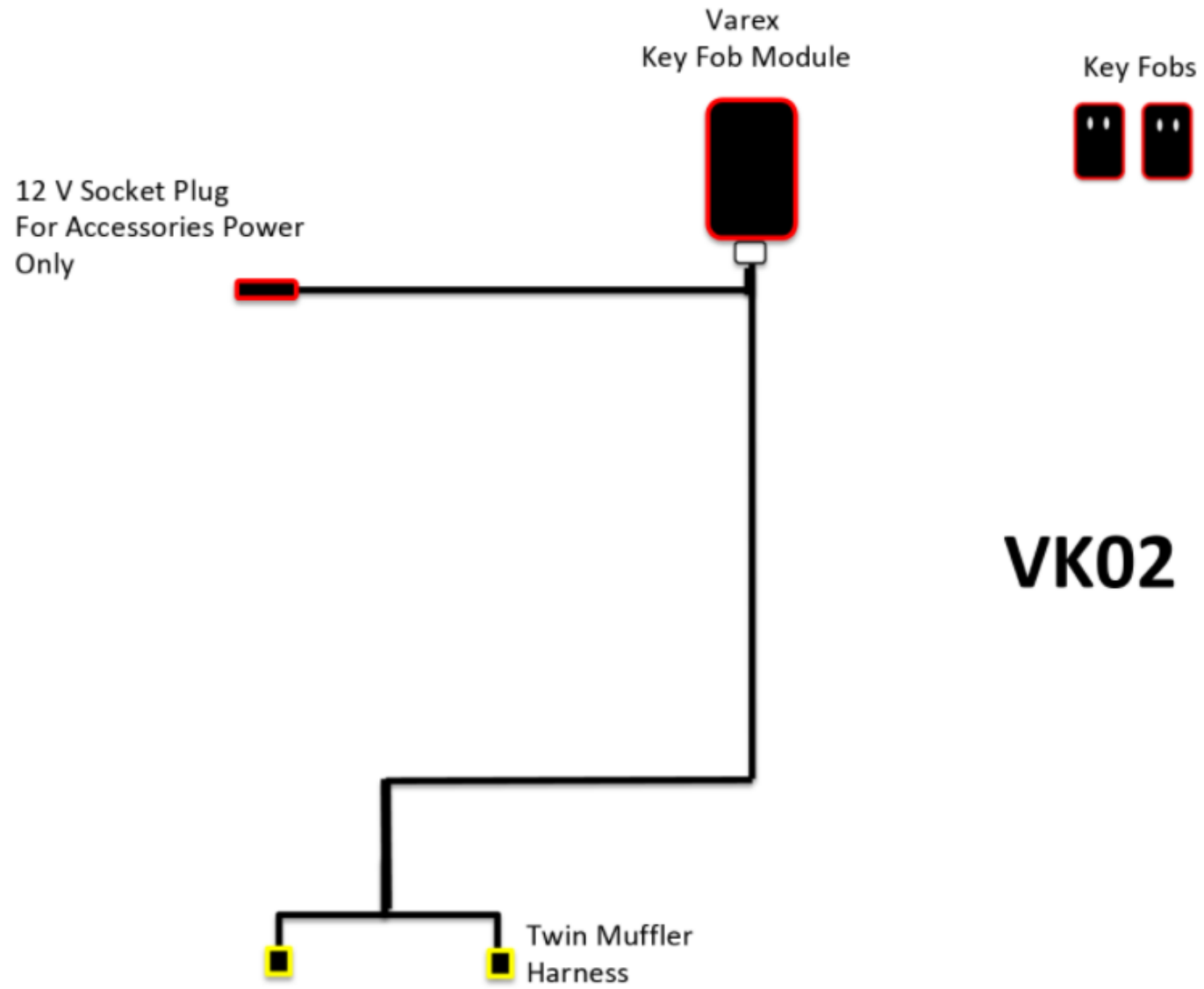



Step 9

Find a rubber grommet to allow access from the boot area to the underside of the car near the Varex Mufflers.

Remove the boot floor cover, Sub and foam surround and in the left front corner there is a rubber allowing access to the underside of the car.

Once located feed the black 2 pin plugs through the rubber grommet and into the underside of the car and connect to the mufflers.





Step 10

Feed the wiring through the boot towards the back seat, then run the wire into the cabin and under the back seat, towards the plastic cover between the carpet and the doors.

Put your fingers under the cover (pic 1) then push the wiring up under the cover (pic 2).

Do this all the way to the front of the cabin and feed the wire behind the kick panel Pic 3 (plastic cover near where your feet would be in the front of the car).



Pic 1

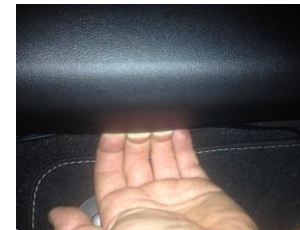

Pic 2

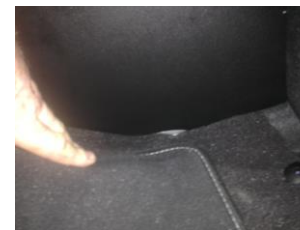

Pic 3



Step 11

Plug the Key Fob box into the white 4 pin plug and the (pic 4)

Remove the panel under the glovebox (pic 5) and place the wiring and box on the panel (pic 6), run the wire (with the 12V Socket Plug) towards the 12V Socket.



Pic 4



Pic 5



Pic 6



Step 12

Feed the wiring under the plastic between the centre console and the carpet moving it towards the centre of the car (pic 7 towards the seats) as far as is needed to reach the power socket (pic 8).

Turn the car on and test the system using the remote
Button A will close the Varex and button B will open the Varex

Now enjoy the volume controllability of your new Varex System



Pic 7

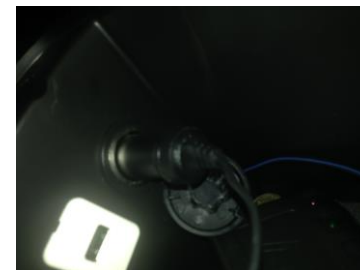

Pic 8



Step 13

Drive vehicle for 10mins, Return to **Step 7**, retention all nuts, bolts and enjoy the driving experience your new Xforce System provides.

Note: When you first start your vehicle after the installation of your new XFORCE Performance Exhaust System, there may be some smoke and fumes coming from the system. This is a protective oil based coating used in the manufacturing of mandrel bent performance exhaust tubing. This is not a problem and will disappear within a very short period of time after the exhaust has reached normal operating temperatures.